

STREAMER RESISTIVITY SURVEYS IN DELMARVA COASTAL BAYS

Frank T. Manheim, Coastal and Marine Geology Center, Woods Hole MA; & Eastern Minerals Team, Reston VA
David E. Krantz, Dept. of Earth Science, University of Toledo, Toledo OH
Donald S. Snyder, Zonge Engineering and Research Company, Tucson AZ
Brian Sturgis, U.S. National Park Service, Assateague Island MD

Introduction

This paper reports on streaming resistivity (“DC resistivity”) surveys conducted in Maryland and Virginia Atlantic coastal bays in the spring of 2001. Surveys in Assawoman, Isle of Wight, and Chincoteague Bays, MD and VA, were used to study profiles of electrical resistivity of submarine strata to delineate submarine freshwater discharge and submarine saltwater interfaces and salinity distributions in submarine groundwater. The studies follow similar resistivity surveys in Rehoboth and Indian River Bays in spring of 2000 (Krantz and others, 2000; Madsen and others, 2001; and Manheim and others, 2001).

The Delmarva Peninsula coastal studies are part of larger cooperative programs between the U.S. Geological Survey, regional federal and state organizations, and academic institutions. They address the problem of excess nutrient discharge into Delmarva coastal bays. Like the Delaware coastal bays, Maryland and Virginia coastal bays receive excess nutrients due to human activities. The excess nutrients enhance growth of phytoplankton and fouling macroalgae, which impedes boat operation, coats beaches, and lays down organic-rich mats. This organic matter fosters anoxic conditions in the bottom sediments. Growing stagnation alters the habitat for benthic organisms and reduces biological diversity. Recent studies suggest that excessive organic growth inhibits natural mechanisms (like denitrification) that help transform and remove nutrients from the bay systems.

Submarine discharge of nitrate-enriched ground waters was inferred from preliminary estimates of land-based hydrologic flow-nets (Andres, 1987, 1992) in the Delaware coastal bays (Rehoboth and Indian River), and modeled by Cerco and others, 1994. Subsequently, as a part of a large consortium study (CISNET) led by the University of Delaware, T. McKenna of the Delaware Geological Survey (2000) and coworkers performed overflights of Rehoboth and Indian River bays in the winter of 1999 (McKenna and others, 2001). Remote sensing (infrared temperature measurements) of surficial coastal waters in the winter detected a number of areas where warmer water anomalies signified submarine discharge in the near-coastal environment.

A recent summary (Dillow and Greene, 1999) based on land data estimates that roughly 24% (272,000 pounds) of the total nitrate loads from groundwater enters the Maryland bays through submarine groundwater discharge (SGD). This nitrate flux is associated with about 13% of the estimated 100 million gallons per day total water influx estimated to enter the Maryland coastal bays through SGD. The Maryland SGD fraction is a smaller proportion than estimated for the Delaware inland bays (up to 80%). Dillow and Greene (1999) point out that there is uncertainty about the pathways of submarine groundwater discharge. Postulated pathways range from immediate sub-bay coastal margin discharge (corresponding to the Ghyben-Herzberg model), to long-distance transport in aquifers extending under the barrier bar (Assateague Island) and discharging into the Atlantic Ocean.

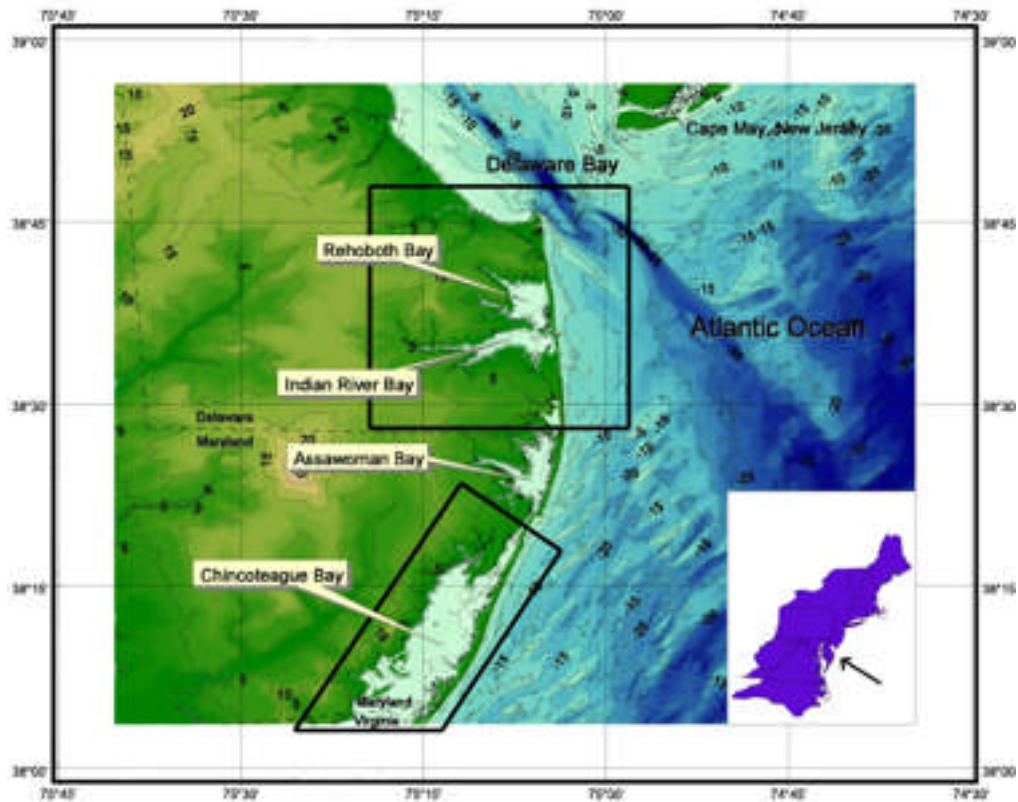

Figure 1. General location map of upper Delmarva Peninsula area, showing Delaware and Maryland coastal bays. Isle of Wight Bay forms the lower part of the area shown as Assawoman Bay, and Sinepuxent Bay is the long, narrow Bay leading to Chincoteague Bay.

The submarine hydrologic and hydrogeologic conditions of estuaries and coastal bays are poorly known partly because of the difficulty in making measurements comparable to those on land (i.e., stream gaging and hydrogeological measurements in boreholes). To gain information on the submarine hydrology of the coastal bays the U.S. Geological Survey Coastal and Marine Geology program (Woods Hole, MA and Reston, VA) initiated experimental studies in cooperation with USGS's Water Resources Division (WRD, Baltimore and Dover district offices) in 2000 and 2001. Techniques employed included streamer resistivity surveys, followed by coring and interstitial water studies. These were designed to complement land hydrogeologic studies and address problems of concern to the National Park Service, (Assateague Island National Seashore), and the Maryland Dept. of Natural Resources (Coastal Bays Program). Along with these investigations, additional geophysical data collected using "CHIRP" or high-resolution seismic surveying (University of Delaware, Dept. of Geology, Newark, DE), and medium frequency seismic profiling ("Geopulse") (WRD Dover, DE and Storrs, CT) are providing supplementary information on sediment stratigraphy and structural relationships.

Methods

Shipboard

Zonge Engineering multichannel streamer and associated measurement and data acquisition systems were used for the coastal surveys. The Zonge system has been described in detail by Snyder and Wightman (1998) and will be discussed only briefly here.

Streamer cable system

The streamer is a 120 m polyethylene-coated cable with 8 pairs of 22 ga. wires. Each insulated takeout (including the current electrodes) is connected to a conductor pair. The last two takeouts share the eighth pair (Figure 2). The cable is buoyed to float on the water surface with six-inch marine docking fenders attached to the cable at each electrode (Figure 3). The electrodes spacing is 10 m (32.8 feet). The two electrodes closest to the towboat are used as current electrodes. The other seven are connected as adjacent pairs to form six receiver dipoles.

Resistivity measuring system

The Zonge GDP-32 Multi-Function receiver, with seven analog channels, a ZT-30 TEM/Resistivity transmitter, and a high-voltage DC-DC converter measured electrode resistivities. The transmitter was powered by 24-volt DC power. For the Maryland surveys, a pair of automotive batteries supplied power with four additional marine batteries in reserve as backups. This system delivered up to 8 amps for a full working day. This was twice the service time of the system previously employed in the Delaware bays. The GDP-32 receiver was operated continuously, except when cable was pulled on-board in order to move to a new location at high speed.

Data Acquisition Subsystem

Two serial RS-232C data streams, navigation and resistivity, were captured and stored as separate data files with a laptop computer. The system was operated in continuous mode, with measurements collected at two-second intervals.

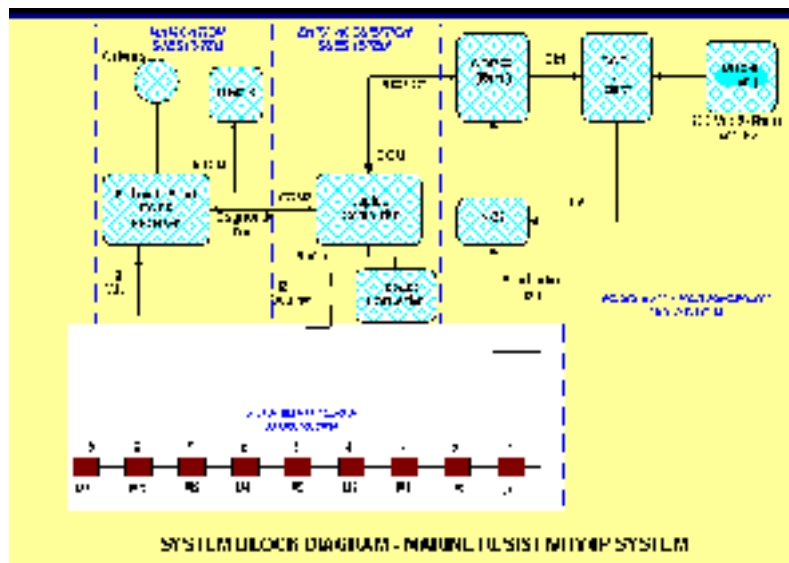

Figure 2. Schematic diagram of Zonge marine resistivity system (from Zonge report to USGS, 2000).

Navigation

A differential GPS navigation system was provided by the National Park Service. The receiver was connected to a laptop computer running HyPack*, a PC-based hydrographic survey software package. Hypack reported both GPS position (NMEA sentence \$GPRMC) and a special navigation sentence (\$CCXYZ) containing X and Y coordinates together with fathometer and other ancillary data. The coordinate system used was the Maryland State Plane.

Data processing and interpretation

Following acquisition of the data, about 112 km of the 178 km collected were processed by smooth-model inversion to convert resistivity measurements to model cross-sections. The work was done by Zonge with its TS2DIP* (v. 3.02) software package. A finite-element, forward-modeling algorithm is incorporated in this application, which calculates apparent resistivity and phase values generated by 2-dimensional models. The output is created for short (up to about 3000') sections of the lines. The finite-element mesh is draped over the topography, and output in the form of contour profiles is plotted using Surfer software. Samples of these and other interpretation products will be shown below.

The remainder of the data (about 66 km) will be processed with an updated processing system that is capable of correcting for the effect of the salty water column on sub-seafloor data. The water depths in Chincoteague and the other coastal bays are generally shallow, often less than three feet. However, because of the wide spacing of the electrodes (30 feet) this salt content strongly biases the upper 15 feet or more of sediment profiles.

[* Mention of commercial products in this paper is for descriptive purposes only, and does not imply endorsement by the U.S. Geological Survey or the Dept. of Interior.]



Figure 3. Instrument setup inside powerboat. To left: resistivity control and data acquisition system, with Donald Snyder. To right: GPS navigation recording equipment.

Other equipment

A continuously-operating multichannel probe (Hydrolab) was towed on a short tether line during surveying. It measured salinity (‰), conductivity (mS/cm), temperature (degrees C), pH, dissolved oxygen, and redox potential. Conductivity, salinity and temperature were also measured at intervals of a few minutes with a manual probe. The probe, an Orion Model 140 conductimeter, was inserted into surficial bay water collected with a small bucket on a rope. The automatic and manual data were complementary, in that the automatic data provided continuous information, but were subject to greater scatter because of the effect of turbulence on the towed probe (at five knots). A systematic offset between the two conductivity measurements was determined to be due to the fact that the Orion instrument was calibrated for 20°C, whereas the Hydrolab instrument was calibrated for 25°C.

Operational details

Vessel speeds were increased from the 2.5 knots maintained in the earlier Delaware surveys, to 5 knots in open water. Slower speeds were normally utilized when traversing very shallow water (< 2') or hugging coastlines.

After mobilization, traverses from Assateague Station dock were planned in such a way that the first day consisted of extensive coastal profiles along southern Sinepuxent Bay and northern Chincoteague Bay, cutting across the bay for the first cross-bay transect. The next day operations continued in central and southern Chincoteague Bay and included another cross-bay transect. On the third day a variety of survey transects in smaller creeks and inlets in Isle of Wight Bay (including Herring Creek) and Assawoman Bay were performed, including a coastal segment along densely populated Fenwick Island (Ocean City MD). The final day was spent in the southernmost part of the Maryland sector of Chincoteague Bay and the Virginia sector, including Assateague Bay and Tom's Cove. It proved difficult to approach Assateague Island because of very shallow water (<2'), but close



Figure 4. Resistivity streaming in Indian River Bay. Resistivity streamer with floats distant left. Seismic streamer (short) on right. The powerboat (USGS Storrs) and a University of Delaware (Newark) pontoon boat supporting the seismic gear are temporarily lashed together to steam in tandem

approaches were possible in three widely separated places.

As noted in the data samples provided in this report, fresh subsurface water was found as far as 1 km off the western shores of the investigated bays. Only brackish water was found in the central-southern barrier-bar region (Assateague Island). Fresh waters were found, however, off the urbanized coast of Fenwick Island (Ocean City MD).

Personnel, Cooperators, and Acknowledgments

Shipboard staff

Frank T. Manheim, Chief Scientist (USGS, Reston VA)

David Krantz, Hydrologist (USGS, Dover DE; now University of Toledo)

Tim Nordstrom, Geophysical Engineer (Zonge Engineering, Tucson AZ)

Brian Sturgis, Boat Pilot and Environmental Scientist (U.S. National Park Service (NPS) Assateague Is.)

Cathy Wazniak, Environmental Scientist and Biologist (NPS, guest investigator)

Jeffrey Wynn, Geophysicist (USGS, Reston VA; guest investigator).

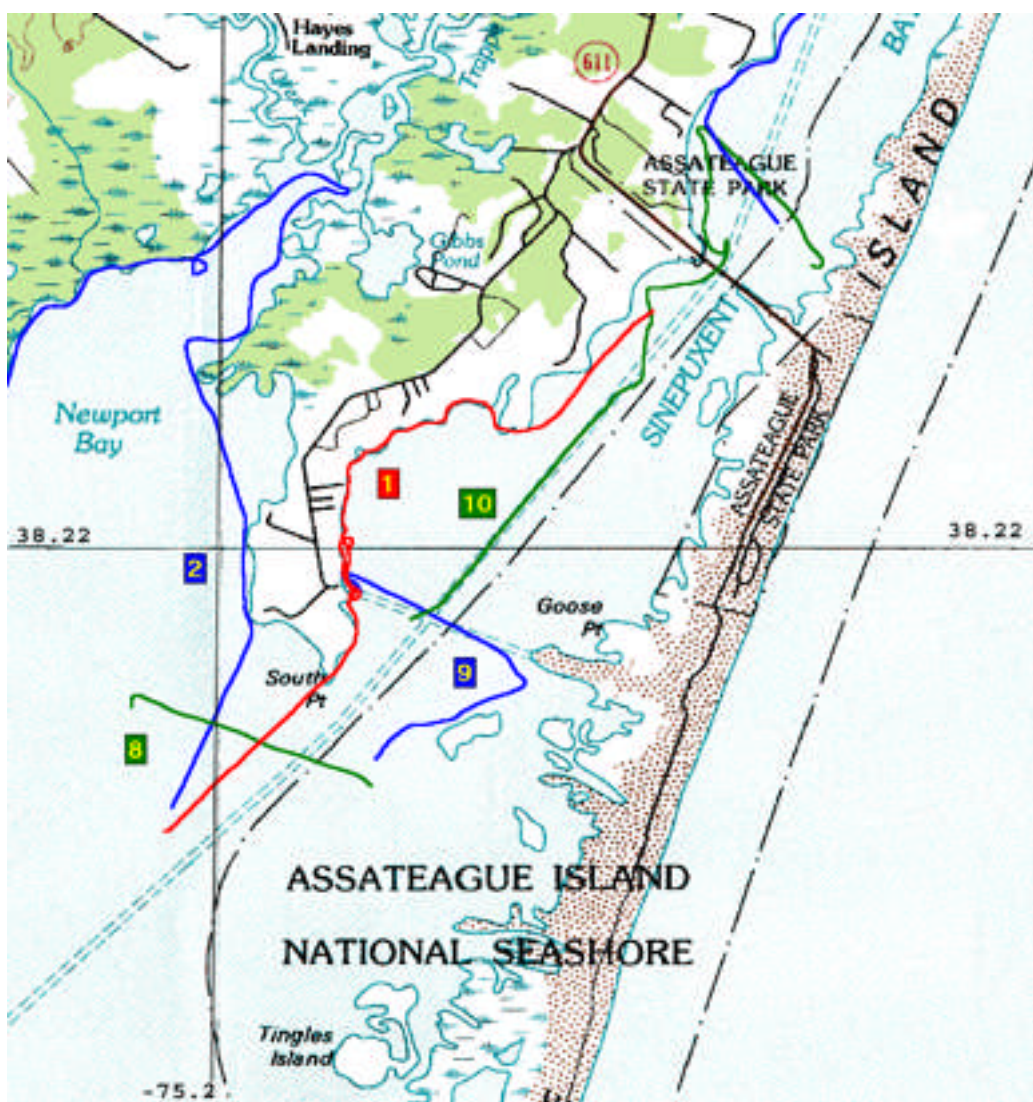

Figure 5. Location map for embarkation point and Line 1. The embarkation point is part of the Assateague Park complex, seen just north of the bridge in Sinepuxent Bay.

We acknowledge the contribution of Robert Shedlock (USGS, Baltimore), who organized a special workshop that aided in the coordination of this effort, Deborah Hutchinson and the Woods Hole Coastal and Marine Geology Center for supplementary funding for data processing. The USGS Hoverprobe group, especially Don Queen is acknowledged for the scheduling the vibradrilling work. Student assistant Mounzar Cooper aided in data preparation.

Finally, gratitude is expressed to the contact persons and organizations without whose in-kind or financial support the extended Maryland and Virginia field surveying and data processing would not have been possible: U.S. National Park Service (Brian Sturgis and Carl Zimmerman), the Maryland Department of Natural Resources (Cathy Wazniak), the Johns Hopkins University Laboratory of Applied Physics, Baltimore MD, (Charles Sarabun), and the Virginia Institute of Marine Science (Mark Luckenbach).



Figure 6. Location for Line 4 (cross-traverse across Chincoteague Bay)

Results

Table 1 shows the line kilometers covered during the four days of surveying. This performance nearly doubled the track kilometers achieved in the Delaware coastal bays in 2000. It demonstrates the speed of data acquisition that can be accomplished by streamer survey.

Table 1. Results of resistivity surveys: kilometers surveyed.

Line ID	Date	Data Points	Dist. mi	Dist. km	Day total
151GPS01	May01	5464	10.16	16.36	
151GPS02	May01	7097	9.93	15.98	
151GPS03	May01	8091	11.41	18.37	
151GPS04	May01	3850	5.39	8.68	59.38
151GPS05	May02	1328	1.66	2.67	
151GPS06	May02	5067	6.83	10.99	
151GPS07	May02	1313	1.80	2.90	
151GPS08	May02	1175	1.63	2.62	
151GPS09	May02	2156	2.59	4.17	
151GPS10	May02	4169	5.62	9.05	
151GPS11	May02	5676	7.53	12.12	44.53
153GPS12	May03	2612	3.42	5.51	
153GPS13	May03	5053	6.83	10.99	
153GPS14	May03	1333	1.74	2.80	
153GPS15	May03	2980	4.19	6.74	
153GPS16	May03	3217	4.84	7.79	
153GPS17	May03	1454	1.81	2.91	
153GPS18	May03	2789	3.46	5.57	42.32
154GPS19	May04	3305	3.91	6.29	
154GPS20	May04	3233	4.24	6.83	
154GPS21	May04	826	1.17	1.88	
154GPS22	May04	2177	2.52	4.06	
154GPS23	May04	2149	3.19	5.14	
154GPS24	May04	1766	2.46	3.96	28.15
Grand total	4 days	78280	108.33	174.38	174.38

Processed results from the Zonge TS2DIP inversion software are produced as groups of three cross sections or pseudosections, as in Figure 7. Each line is subdivided into sections of about 1000', and presented as a triad processed by a Surfer script that is part of the interpretation package.

The lowermost profile in each panel is raw resistivity plotted against dipole number. The middle profile is calculated apparent resistivity, and the top profile is the smooth-model inversion, showing resistivity contours in sections with depth as the vertical axis, and in distance from the start of a line (in feet) as the horizontal axis. The image in Figure 7 is from the end of Line 1 (section j). The section appears again in the set of modeled data profiles (Figures 8-10) which select successive inversion profiles and places them in sequential order along a line transect. In this case the line in question (Line 1) extends from South Point (Chincoteague Bay) southward into open water of the bay.

The blue through purple colors (see resistivity scale key) show a transition to higher resistivity layers, which we interpret as brackish to freshwater layers in saturated sediments beneath the salty bay waters. The highest plotted resistivity interval is >20 Ohm-m in the current format. Where this interval

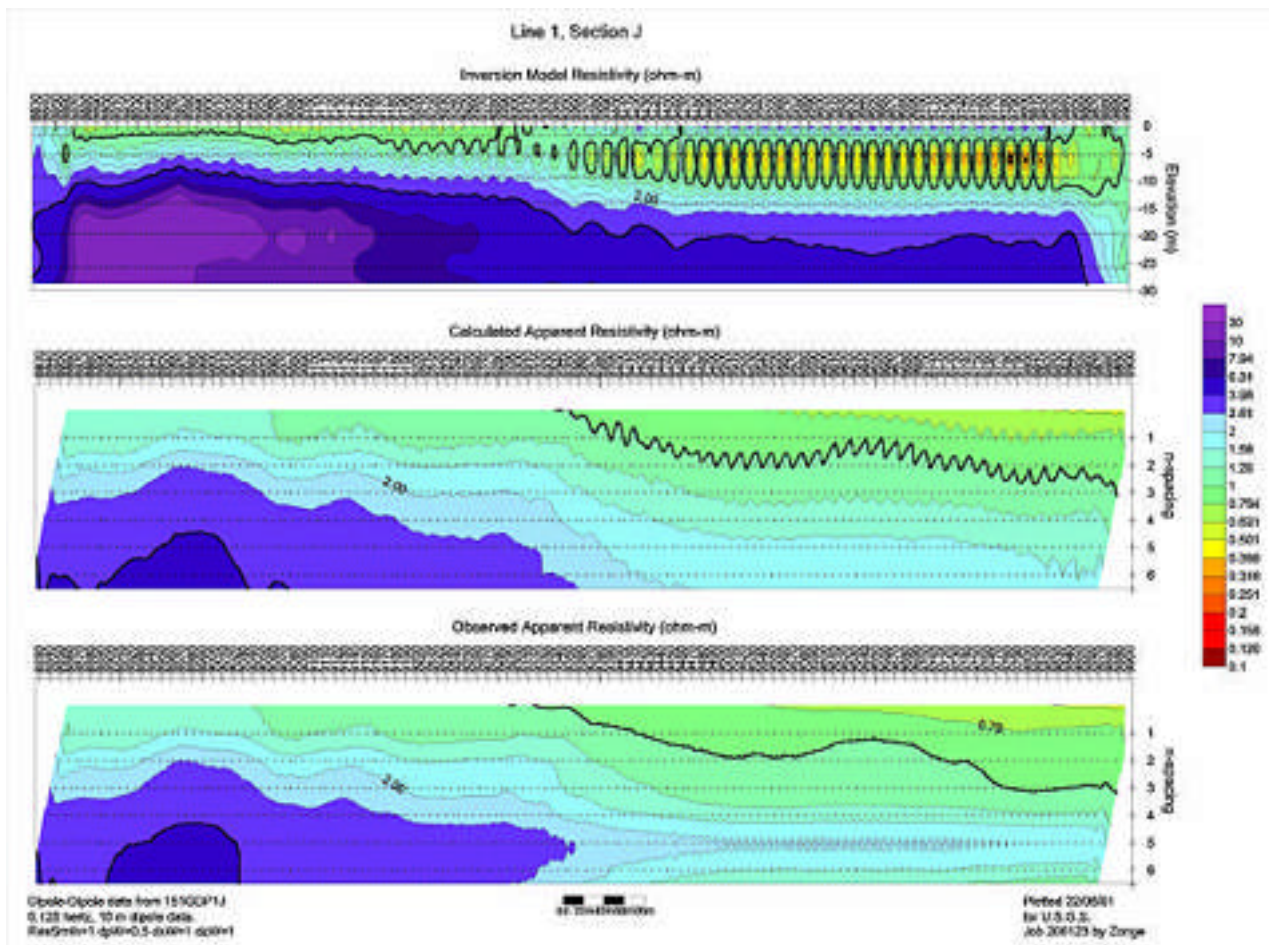

Figure 7. Cross section /pseudosection triad for Line 1j. This section corresponds to the last profile in Figure 10. Bottom segment is observed (raw) data plotted against dipole number on the vertical axis; middle pseudosection is calculated apparent resistivity, and top section is the inversion modeled depth/resistivity layered model.

is well developed there are usually larger resistivity values that don't show up on the plots in the processed data tables. A formation factor correction helps estimate salinity in the modeled strata, as shown later.

Small irregular blips, especially in the surficial layers (to 10 m) are not significant and usually represent noise in the signal or interpretive processing. At each end of a section there will be loss of continuity in the wider-spaced dipoles, causing dropouts and abnormal signals. The sections are overlapped so that continuous interpretive records can be abuted.

The northern sections of Line 1 b-d (Figure 8) show typical variability found on the Western margin of the Delmarva coastal bays. This variability is partly associated with fluctuating changes in elevation from headlands to low marshy areas, interspersed with streams. Stream channels (especially if sited on paleochannels) and headlands tend to produce large offshore freshwater anomalies. Broad, marshy or other low-lying areas (e.g. boat canals) tend to correlate with brackish waters beneath the offshore bays. Exceptions occur where deeper-lying paleochannels underneath the marshes receive water from higher elevations. The smoother offshore freshwater fronts off west-central Chincoteague bay may be linked with a more even, trellised drainage system in contrast to the dendritic system in the Delaware coastal bays.

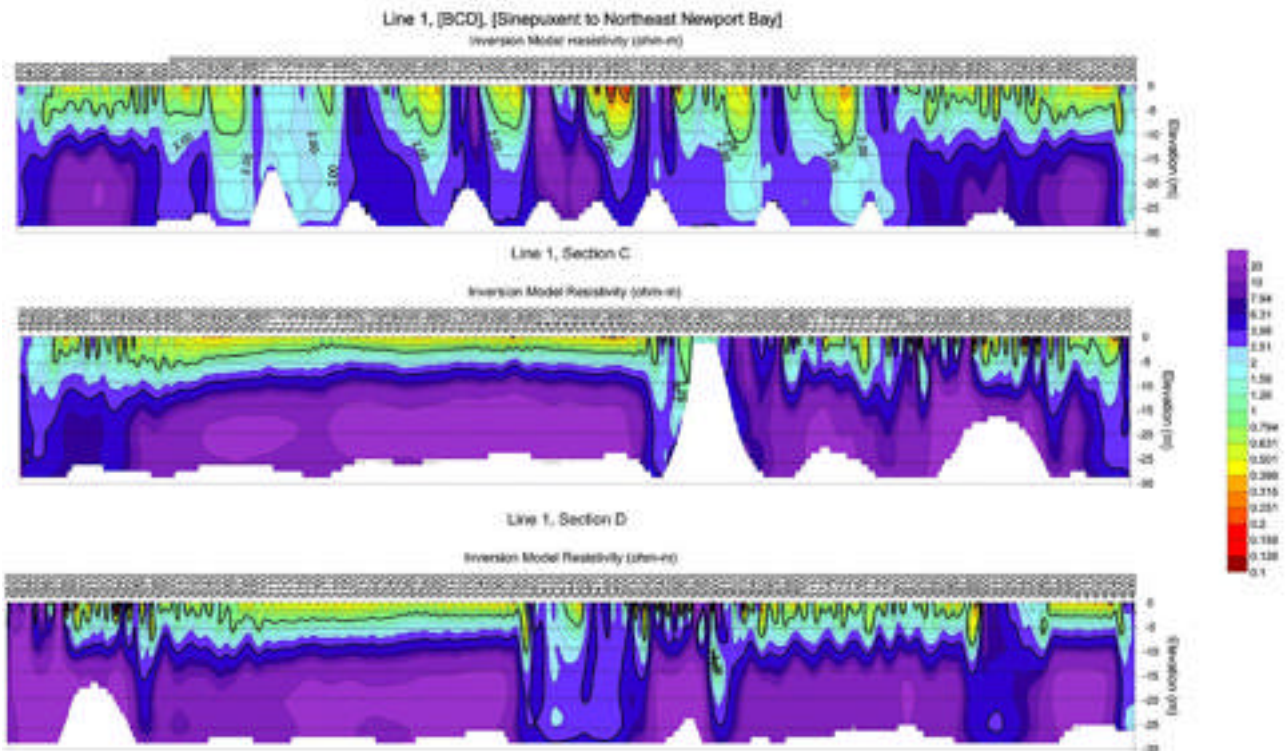

Figure 8. Line 1 b-d. The northern part of Line 1 shows regular oscillations in sub-bay salinity. This corresponds to land topographic features, as noted in the text.

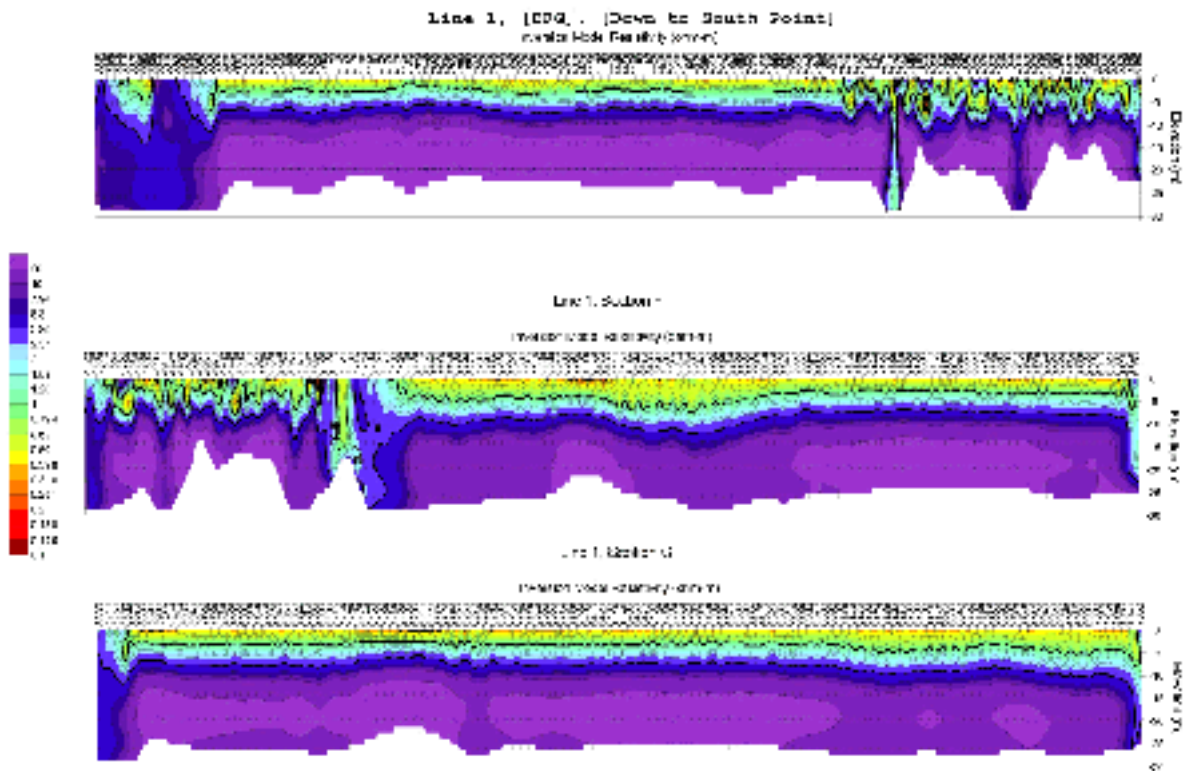

Figure 9. Line 1 e-g. Transition from highly variable near-shore resistivity patterns to smoother (more horizontally-continuous) offshore resistivity contours.

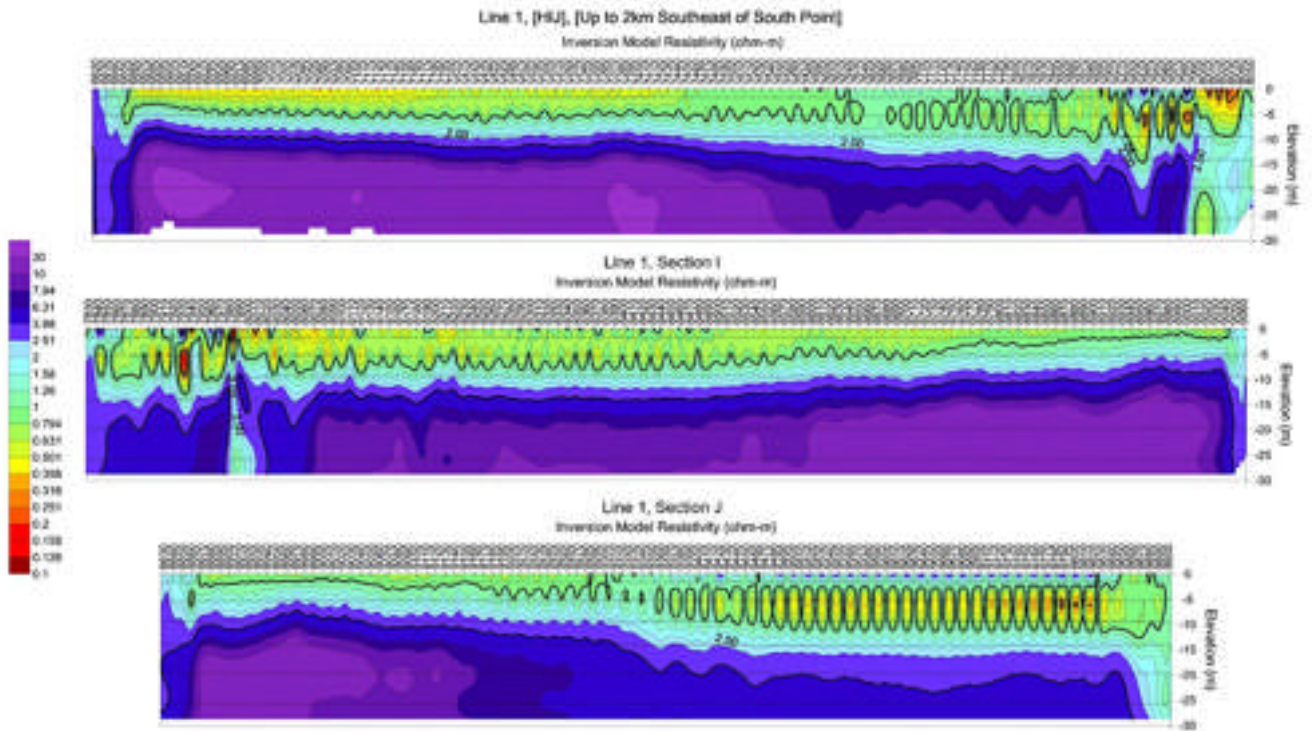

Figure 10. Line 1 h-j. Seaward end of Line 1, showing the vertical narrowing and deepening of the high-resistivity tongue southward but maintenance of a brackish lens over and underlain by more saline water. Note that the sharp cutoff on the right side of the image is an artifact.

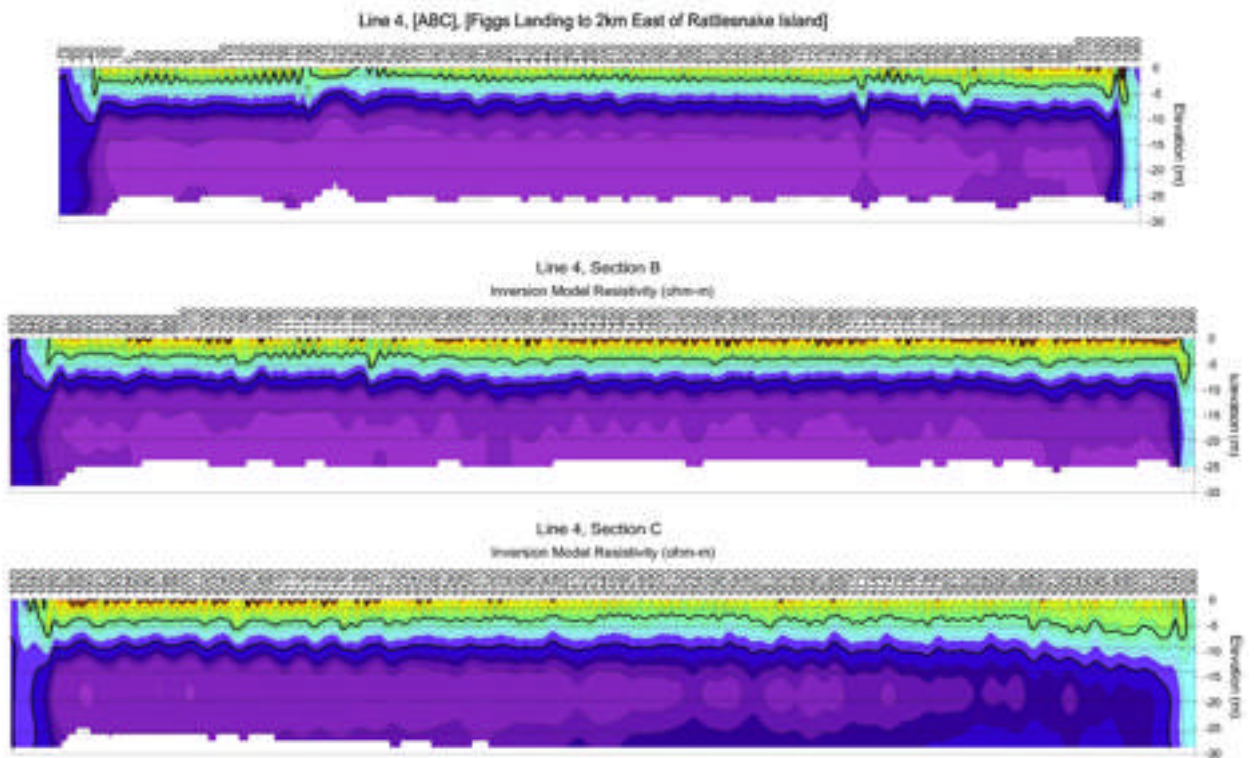

Figure 11. Line 4 a-c. Beginning of the cross-bay, arcuate transect from Public Landing across Chincoteague Bay to Assateague Island.

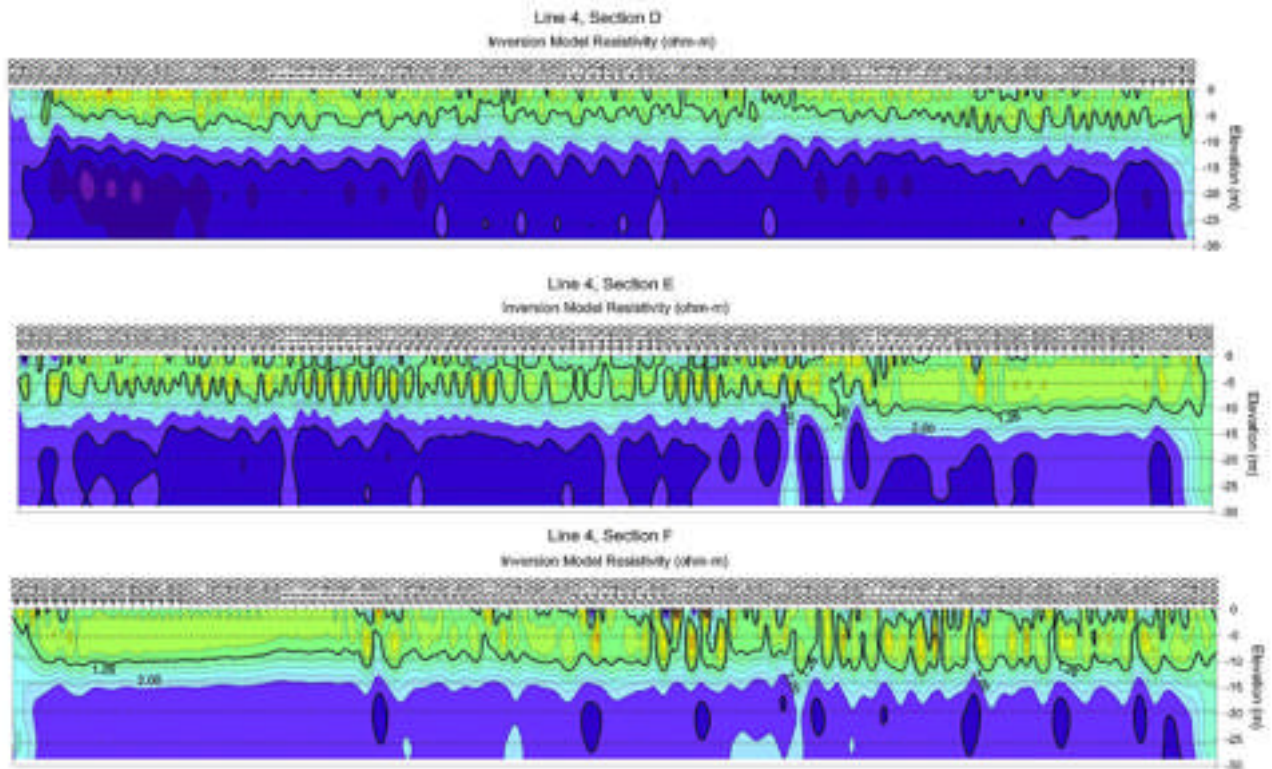

Figure 12. Line 4 d-f. Western-middle section of cross section, showing smoothing resistivity trends with vertical narrowing and deepening of the high-resistivity (fresh water) submarine lens.

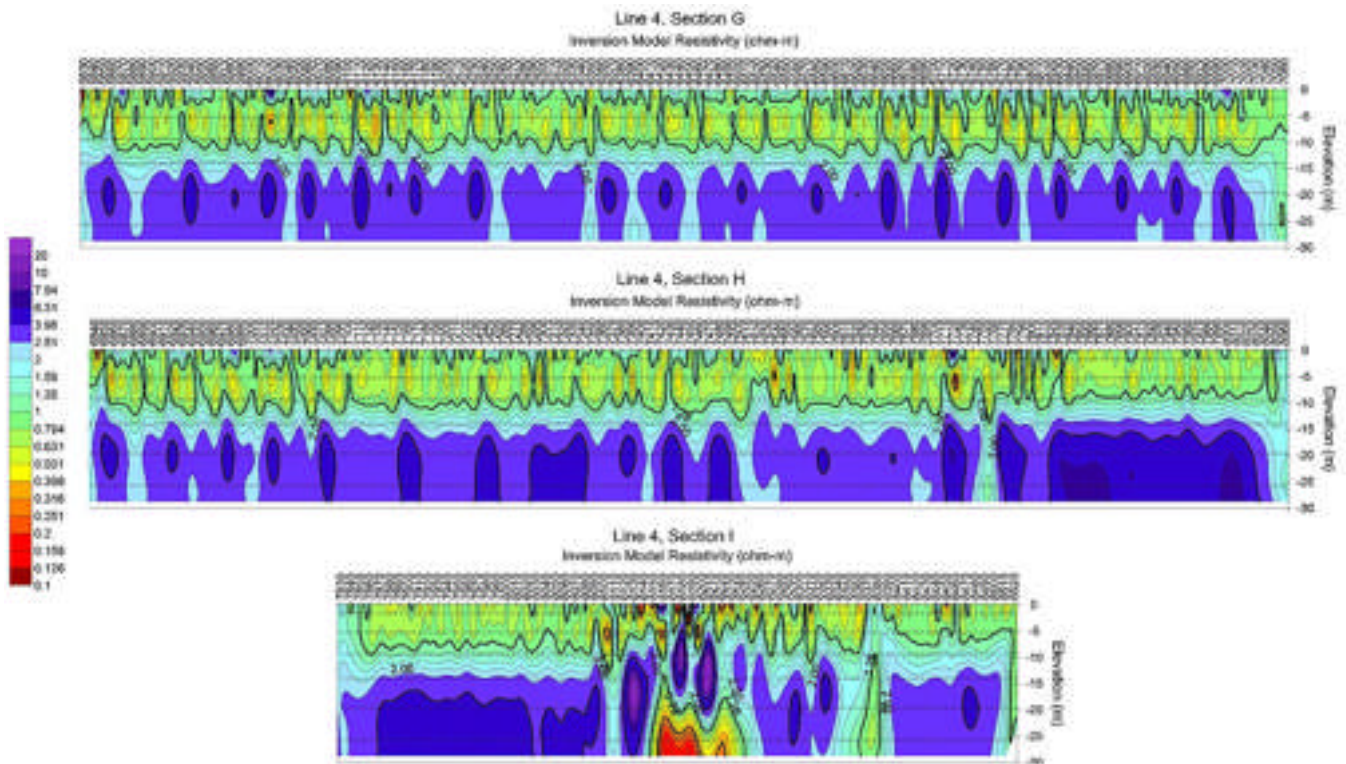

Figure 13. Line 4 g-i. Fresh water beneath surface is replaced by brackish water approaching Assateague Island. Note small hypersaline anomaly toward Assateague Island.

We were particularly interested in Line 4, (Figures 11-13) crossing Chincoteague Bay. It was previously not known how far from land fresh submarine waters extended, and whether there was any systematic or predictable geometry to the discharge or interconnection between fresher waters from deeper aquifers along lines of enhanced transmissibility. To achieve a better display a regional perspective on the changes it was necessary reduce the horizontal scale of the resistivity profiles while expanding the vertical. Compressing the detailed data without either enhancing artifacts and irregularities or losing meaningful detail posed some graphical and interpretive challenges. For the images in Figures 14 and 15 we first transferred data for all sections of the line into a tabular format displaying the fixed depth intervals for resistivity data along a horizontal axis, using an appropriate query in database management software. Then all sections in a line were concatenated and smoothed, using a running average of nine observations. These running averages were subsampled to produce a smaller but still representative list of stations. This list permitted production of shortened profiles. The final step was hand contouring. An alternative running average of geometric means for a smaller number of observations produced a similar effect.

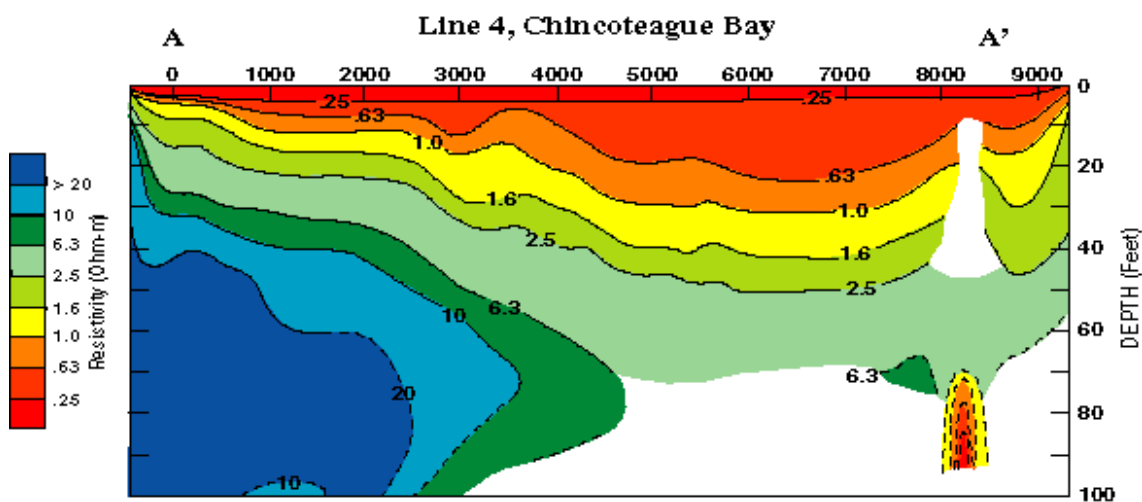

Figure 14. Consolidated resistivity cross-section across Chincoteague Bay (Line 4 a-j). Lower feature toward 8200' depth bay be a narrow hypersaline zone.

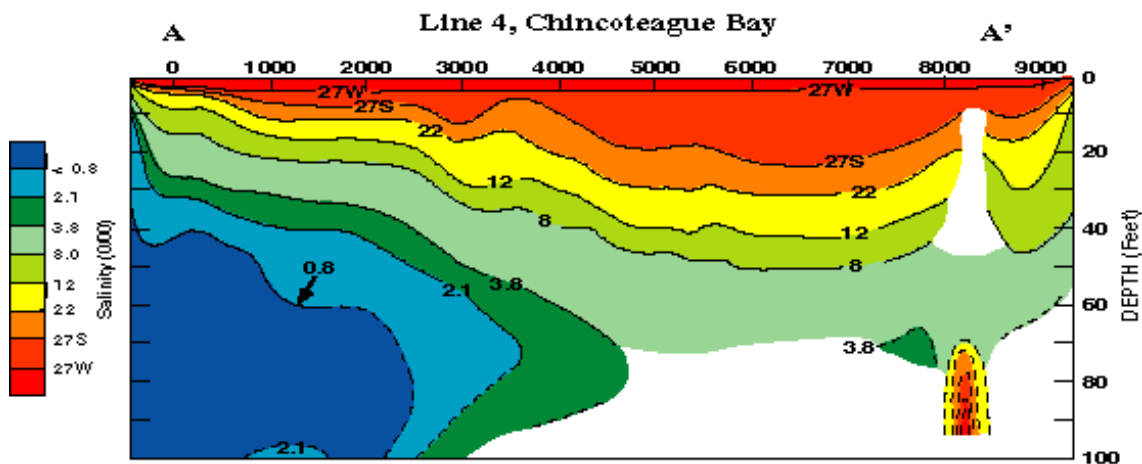

Figure 15. Interpreted salinity profile in water and sediments beneath Chincoteague Bay. Salinities are estimated by dividing interpreted sediment resistivity values by three, and using conversion algorithm from resistivity to salinity (see later section).

The cross section depicted in Figures 14 and 15 shows a fresher lens protruding from the land less than 1 km into the center of the bay, with the depth to the fresher core increasing with distance from shore. The section portrayed here is not deep enough to fully display the lower part of the lens, but the interpreted data, which extends to about 150' indicates that the lens of fresh water gradually becomes more brackish with increasing depth. In order to display the interpreted salinity trends in more widely recognizable units, we applied a formation factor to the resistivity data, i.e. we divided the resistivity values for a formation factor of $F = 3$, where $F = R_s/R_w$. R_s is sediment resistivity and R_w is the resistivity of pore fluid in the sediment in question in Ohm-m. Based on the Public Landing and Holts Neck (Indian River) vibradrillings, the formation factor actually increases from less than 2 at the sediment-water interface to more than 3 at depth, but with the low vertical resolution provided by the 10m dipole spacings refinements were not considered significant for the purpose of this illustration. We then inverted the resistivities to conductivities, and utilized a conductivity/salinity algorithm derived from pore fluid analyses described in the next section. Reference to electrical logs from coastal wells in southern Delaware helped provide assurance that the extrapolation from shallow borings would not create unreasonable interpretations.

Figure 15 shows the resistivity profile in Figure 14 recast as salinity (‰). From these data we can conclude that the freshwater plume has a core with salinities less than 0.8 ‰, or 800 ppm “seawater equivalent” salt content. However, even the deepest part of Chincoteague Bay is underlain by brackish, not fresh water. There is no evidence of any fresh water influence from the center of the bay. The white area toward A' is influenced by data dropouts that render interpretation of the higher intervals less certain. However, we have retained the indication of possible presence of a small hypersaline feature at around 8300' lateral distance. We have done this because of the repeated occurrence of low resistivities at the larger dipole spacings in the raw data, and also because of an extraordinary find of shallow hypersaline brine in two wells in central Assateague Island, not far away from this site (J.J. Dillow, oral and written communication).

Finally, we need to explain the “27w” and “27s” toward the top of the section in Figure 15. 27w reflects the approximate salinity of the water column layer in parts per thousand (‰), as observed in the onboard Bay surface salinity monitoring data. The “27s” layer corresponds to considerably higher



Figure 16. Pier at Public Landing, Chincoteague Bay, Maryland

resistivity values. However, since these reflect sediment data, applying the formation factor mentioned above brings the shallow pore fluid down to values similar to those in the surface water.

From these cross sections it is evident that saltier water is penetrating deeper in the center of the bay. Moreover, the Assateague Island side of the bay shows no evidence of a freshwater anomaly as is found on the western side; submarine pore waters close to the island remain brackish, not fresh.

Field Evidence Supporting The Resistivity / Salinity Anomalies And Submarine Discharge: Hoverprobe Core Drilling

Core drilling operations planned to supplement the resistivity surveys are scheduled for 2002 at this writing. However, early corroboration of the results of the resistivity profiles was obtained in June 2000 during an experimental deployment of the USGS “Hoverprobe 2000.” Hoverprobe is an experimental hovercraft fitted with a high-performance vibradrilling system (Figs. 17-18).

Hoverprobe was transported by trailer to Public Landing, MD, where it was launched under its own power down the boat ramp and into the experimental area. The first and most extensively documented boring was made while the vessel was secured to the end of a long pier extending about 120 m from shore. Pore fluids were obtained to a depth of 30’ by a combination of squeezing of core samples and pumping water samples from a driven wellpoint. As may be seen in Table 2, conductivity and salinity analysis of pore fluids revealed abrupt occurrence of a fresh water aquifer at about 10’ beneath the sea floor. This water was potable and contained measurable oxygen, whereas overlying strata were black, anoxic, and smelled of hydrogen sulfide. These conditions can be best explained by submarine advection of fresh groundwater. To test for possible evidence of permeation of fresh water through the nearshore sediment, the upper few cm of bottom sediments off the bulkhead demarking the parking lot along the pier at Public Landing (MD) were tested with a calibrated conductivity probe. Evidence of upward permeation of lower-salinity water through reduction of salinities was observed within a few tens of feet of shore. We recognize that the bulkhead built in constructing and protecting the parking lot does not provide a natural condition at this site.



Figure 17. Hoverprobe beginning work off Public Landing; Pilot: Michael Herder

Table 2. Conductivity, salinity and resistivity of pore fluids for Site 1, Hoverprobe core at Public Landing, MD. Conductivity is normalized to a temperature of 20°C, and resistivity is derived from conductivity by the relationship $R = 10/C$.

Depth (cm)	Depth (ft)	Sample type	Conductivity (mS/cm)	Salinity (o/oo)	Resistivity (Ohm-m)
3	0.10	Squeezed core	39.4	27.9	0.254
6	0.19	Squeezed core	40.2	28.5	0.249
9	0.29	Squeezed core	41.8	29.8	0.239
22	0.71	Squeezed core	39.6	28.0	0.253
42	1.36	Squeezed core	39.1	27.6	0.256
62	2.00	Squeezed core	39.1	27.6	0.256
82	2.65	Squeezed core	36.0	25.2	0.278
102	3.29	Squeezed core	36.0	25.2	0.278
122	3.94	Squeezed core	33.7	23.4	0.297
142	4.59	Squeezed core	32.5	22.5	0.308
156	5	Pumped	32.0	22.6	0.313
162	5.23	Squeezed core	29.6	20.3	0.338
182	5.88	Squeezed core	31.0	21.4	0.322
202	6.52	Squeezed core	32.5	22.5	0.308
225	7.27	Squeezed core	34.5	24.0	0.290
306	10	Pumped	37.7	26.8	0.265
459	15	Pumped	0.3		35.5
765	25	Pumped	1.3		7.7
918	30	Pumped	2.5		4.0

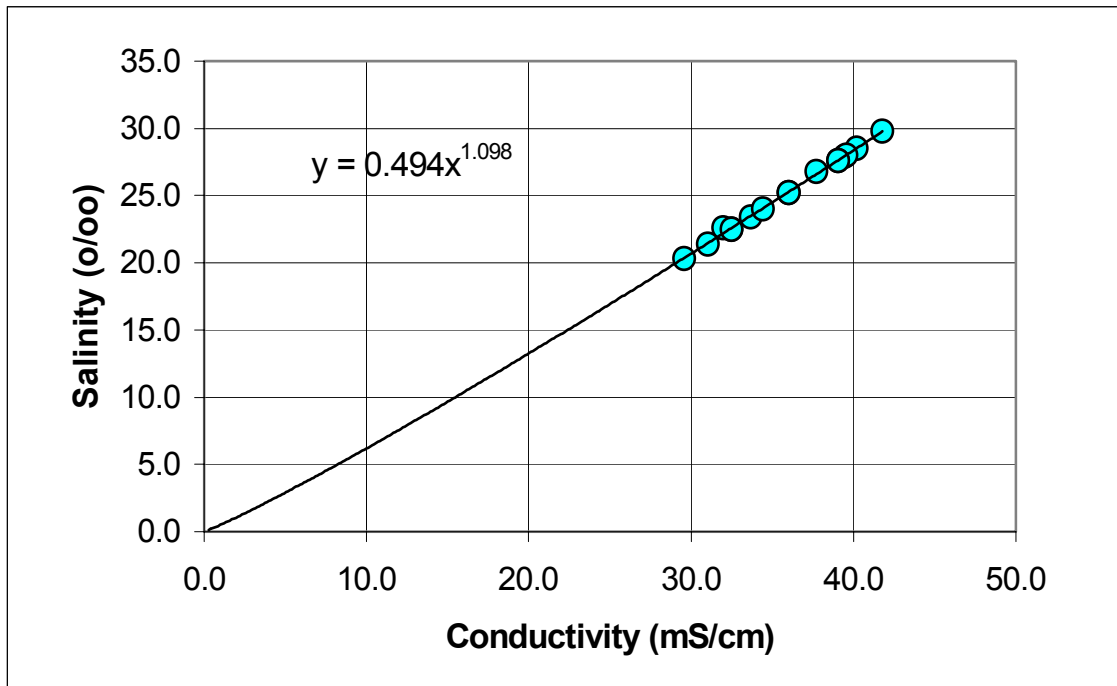

Figure 18. Correlation of measured conductivity and salinity (conductivity normalized to 20°C) for the Public Landing cores, and equation.

Another corehole drilled by Hoverprobe about 0.4 miles from shore likewise demonstrated a sharp decrease in salinity, though it did not penetrate deep enough to reveal potable water.

Discussion And Conclusions

The Zonge multichannel streamer system, first designed for use in the Ohio River, increases the rate of measurement over those achieved in land-based resistivity methods from 30- to 70-fold. These factors were calculated by utilizing the Zonge Engineering “Roll-Along” Dipole-Dipole Resistivity/IP system on land (to 2000 feet per day) for comparison with currently employed marine systems. This made possible extensive evaluation of a total of about 260 km of field surveys in 9 days actual operating time summing total time in the Delaware, Maryland, and Virginia surveys. The useful penetration varied from about 40’ to about 150’. Statistical reproducibility criteria produced in processing provide a guide to depths that can be reliably interpreted.

The presence of seaward-extending freshwater horizons extending under the western margin of Chincoteague Bay and the more northerly Maryland bays is prominent and unmistakable, and has been confirmed in vibradrilling and pore fluid studies.

The origin of the brackish water “sandwiches” off even low-lying coastal areas and more central bay coastal areas in the Delmarva Peninsula pose a special problem. These invite examination of their implications for both dynamic hydrologic models, including possible involvement of “paleosalinities” inherited from earlier geologic periods when the coastal region was exposed to freshwater recharge on land.

Use of horizontal “DC resistivity” in coastal bays provides optimum conditions of extreme resistivity (conductivity) contrast between salty and fresh water, under conditions where formation factors in unconsolidated sediments exert relatively moderate influence on sediment resistivities.

References

Andres, S.A., 1987, Estimate of direct discharge of fresh ground water to Rehoboth and Indian River Bays: Delaware Geological Survey Report of Investigations No. 43, 37 p.

Andres, S.A., 1992, Estimate of nitrate flux to Rehoboth and Indian River Bays, Delaware through direct discharge of ground water: Delaware Geological Survey Open File Report No. 35, 36 p.

Cerco, C.F., Bunch, B., Cialone, M.A., and Wang, H., 1994, Hydrodynamics and eutrophication model study of Indian River and Rehoboth Bay, Delaware. U.S. Army Corps of Engineers Waterways Experiment Station Technical Report EL-94-5, chapter paginated, 9 chapters.

Dillow, J. J., and Greene, E.A., 1999. Ground-water discharge and nitrate loadings to the coastal bays of Maryland. U.S. Geological Survey Water-Resources Investigations Report 99-4167, 8 p.

Heiland, C.A., 1946, Geophysical Exploration. New York, Prentice-Hall, Inc., 1013.

Krantz, D.E., Manheim, F.T., Bratton, J.F., and Madsen, J.A., 2000, Hydrogeological framework and ground-water transport pathways to coastal bays, Delmarva peninsula, Geological Society of America, Annual Meeting, Abstracts with Programs, v. 32(7), Reno, Nevada.

Madsen, J.A., Brown, L., McKenna, T., Snyder, S., Krantz, D., Manheim, F., Haeni, F.-P., White, E., and Ullman, W., 2001, Geophysical characterization of fresh and saline water distribution in a coastal estuarine setting. Application of Geophysics to Engineering and Environmental Problems (SAGEEP), March 4-7, Denver CO (Abs).

Manheim, F.T., Krantz, D.E., Snyder, D.S., Bratton, J.F., White, E.A., and Madsen, J.A., 2001, Streaming resistivity surveys and core drilling define groundwater discharge into coastal bays of the Delmarva Peninsula, GSA Annual Meeting Abstract, Nov. 1-10, p. A42.

McKenna, T.E., Andres, S.A., Wang, L.T., and Deliberty, TL., 2001, Mapping locations of ground-water discharge in Rehoboth and Indian River bays, Delaware, using thermal imagery. GSA Annual Meeting Abstract, Nov. 1-10, p. A44.

Snyder, D.S., and Wightman, E., 1998, Application of continuous resistivity profiling to aquifer characterization, Symposium on Application of Geophysics to Environmental and Engineering Problems (SAGEEP), 18 p.