

CONTINUOUS RESISTIVITY PROFILING IN SHALLOW MARINE AND FRESH WATER ENVIRONMENTS

D.D. Snyder, Scott C. MacInnes, M.J. Raymond, and Kenneth L. Zonge
Zonge Engineering and Research Organization
Tucson, AZ
SkipS@zonge.com

ABSTRACT

In this paper, we describe an instrument system for performing continuous resistivity profiling in shallow freshwater and marine environments. Using a streamer cable containing 9 electrodes, the system continuously samples the dipole-dipole resistivity at n-spacings 1 through 6. The system can be installed aboard a variety of small inboard or outboard powered vessels in a few hours. Hand-held or marine GPS units provide location information that is recorded by a laptop computer. With this system, up to 40 line-km/day of dipole-dipole data have been collected. The resistivity data are merged with the GPS positions as a post-processing step. The final step in the post-processing is the inversion of overlapping segments of each profile using a 2-D smooth model. The inversions provide high resolution images of the geoelectric cross-section. The depth of investigation ranges from 20-30 m, with a 10 m dipole spacing. Over the last 4-years, we have performed surveys on the Ohio River, near Louisville, KY, on tidal estuaries and bays along the Atlantic coast in Delaware, Maryland, Virginia, and North Carolina, and in Tampa Bay, Florida. Data from these surveys will be used to illustrate the final deliverable from a survey.

INTRODUCTION

The electrical resistivity or conductivity of the shallow sub-surface is of particular interest to environmental geophysicists. It is a physical property directly affected not only by the presence of conducting foreign material that may have been improperly disposed of, but also by the chemistry of the saturating fluids. Environmental hydrologists are sometimes able to use resistivity measurements to map contaminant plumes as they migrate down the hydraulic gradient from their source. Moreover, hydrologists know that fluid migration within our aquifers is an important source of contamination in our lakes, rivers, and tidal estuaries. Thus, resistivity measurements can be valuable for investigation of shallow ground-water hydrology from the waterside as well as the landside.

Four years ago, Zonge Engineering assembled an instrument system to conduct a towed-array resistivity survey on the Ohio River near Louisville, KY. Since that time, we have had the opportunity to conduct a number of other surveys with that system, in both shallow freshwater and shallow marine environments. In the main, these surveys have been conducted in support of groundwater and environmental investigations. However, our experience suggests that these surveys may be effective in mapping or locating conductive features such as buried culture and, possibly, UXO. Our purpose here is to describe our system for measuring resistivity and IP in shallow water, and the data processing involved. We will also share in a general way how these data are currently being used. Several other papers being presented at this year's SAGEEP speak more directly to specific applications.

BASIS FOR RESISTIVITY MEASUREMENTS IN SHALLOW WATER

Qualitatively, resistivity measurements in shallow water can be viewed in much the same way as borehole resistivity measurements. In the borehole environment, the borehole fluid causes a “departure” of observed resistivity from the true formation resistivity. In an otherwise uniform space, making the electrode array spacing large when compared with the borehole diameter can make the resistivity departure negligibly small. Well log analysts have calculated departure correction charts for many types of electrode arrays (e.g., normal array, lateral log, etc). The departure curves facilitate correcting resistivity readings for the effects of the borehole annulus and for effects of thin beds (i.e., beds whose thickness is not large compared with the electrode spacing).¹ Similarly, we expect that the “departure” of the measured resistivity from the resistivity of the sub-bottom will be relatively small, provided electrode array dimensions are relatively large with respect to water depth.

We have chosen to use the dipole-dipole array for our measurements because it is a 4-electrode array that requires no remote (i.e., infinite) reference electrodes and is therefore easy to implement on a towed cable. Moreover, provided a multiple-channel receiver is available, receiver dipoles at different n -spacings can be measured simultaneously and so affect a combination of profiling and sounding. The latter reasoning, it seems to us, provides a compelling reason for using the dipole-dipole array for all of our marine surveys.

We have confirmed and to some extent quantified this assumption by computing a set of departure curves for the in-line dipole-dipole array measured at the surface of a 2-layer earth for integer n -spacings ranging from 1-6. Figure 1 shows sets of these curves computed for $n=1$, and $n=6$, respectively. The dipole-dipole array geometry is illustrated in the Figure insets. In the Figure, the abscissa is the thickness of the top layer expressed in units of the dipole spacing (a). The ordinate is the observed or apparent resistivity normalized by the true resistivity of the top layer (ρ_1). The 4 curves represent different sub-bottom resistivities.² These curves show that the departure of the observed apparent resistivity from the true resistivity of the sub-bottom is no larger than 50 percent when the water depth is less than $a/2$ for bottom sediments saturated with the water representing the top layer ($\rho_2/\rho_1=3-5$).

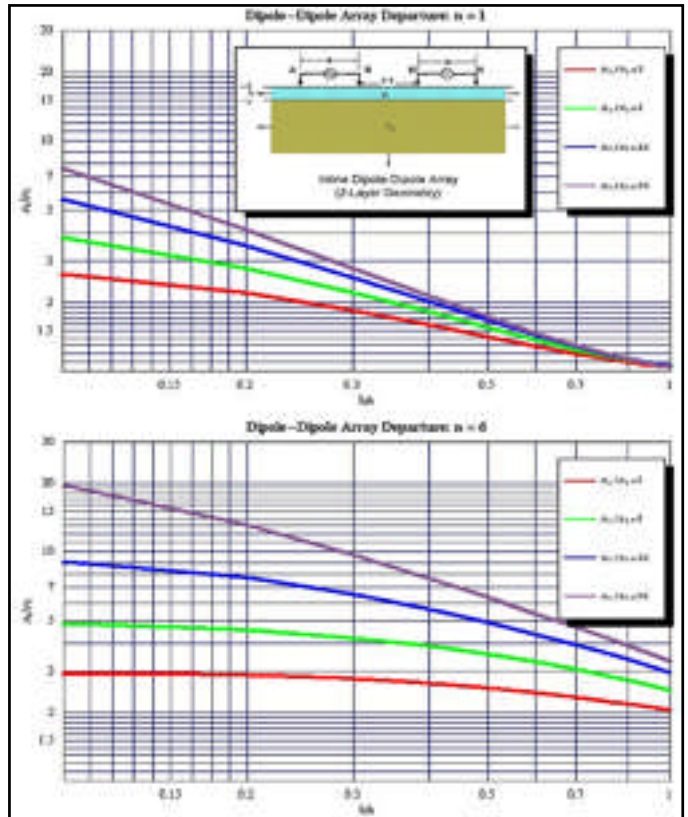

Figure 1: Resistivity departure for the inline dipole-dipole array over a 2-layer geometry.

¹ Departure charts for normal and lateral array resistivity logs can be found in many of the older manuals published by major well log service companies (e.g., Schlumberger [1]1. Schlumberger, *Log Interpretation Charts*. 1972, Schlumberger Limited.).

² The formation factor (F) that is typically associated with unconsolidated sub-bottom (sand/silt) is 3 to 4.

On the basis of departure curves such as those in Figure 1, and catalogs of three-layer curves published by Charles Elliot [2], we fabricated our first streamer cable in the summer of 1997 with electrodes spaced at 10-m intervals. With this cable, therefore, we can feel assured of being able to adequately measure the resistivity of the sub-bottom in water depths of up to 5 m or more. Figure 1a

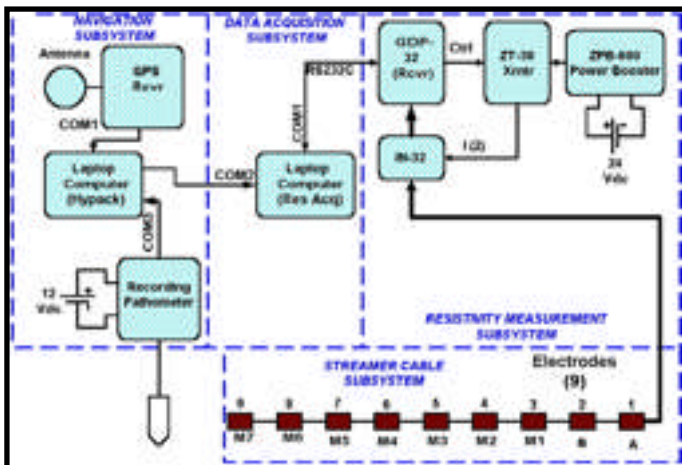

Figure 2: Functional block diagram of marine resistivity/IP system



Figure 3: Photograph showing installed system aboard a 22-ft Boston Whaler.

shows that with a water depth of 5 m it would be difficult to resolve a change in the sub-bottom resistivity from 10 to 30. However, changes at such high resistivity contrasts are easily resolved at the larger n -spacings.

INSTRUMENT SYSTEM

Figure 2 shows a block diagram of the marine system that we have deployed to conduct the shallow water resistivity surveys. The photograph in Figure 3 shows one of the authors with the marine resistivity/IP system installed for one of our recent surveys. The small photograph inset into Figure 3 shows the survey vessel for this installation. As Figure 2 indicates, the system is comprised of 4 main sub-systems:

1. Streamer Cable
2. Navigation
3. Resistivity/IP Measurement
4. Data Acquisition

Streamer Cable Sub-System

The streamer cable consists of a multi-conductor cable that is approximately 120 m long. Nine take-outs have been constructed at 10 m intervals using a 3M (PN 82-F2) vulcanizing splicing kit. At each of the take-outs, one of the cable conductors is brought through the take-out splice and terminated with a “weather-proof” socket connector (Grote PN 66160).³ The electrode is formed using a length of tinned copper tubular braid that has been slipped over the cable and positioned at one of the takeouts. We used a length of foam pipe insulation to cover the takeout splice and cable and to provide a backing material so that the copper braid expands to its maximum diameter that is considerably larger than the

³ Weatherproof automotive connectors can be used for streamers meant to float on the surface. More expensive waterproof connectors are more appropriate for submerged cables.

streamer cable or the 3M splice. Photos of the electrodes are shown in Figure 4. For this cable, we enlarged the current electrodes (Figure 4, bottom) to reduce their contact resistance for surveying in freshwater. This is not necessary if the survey is to be conducted in salt water since the contact resistance for the smaller potential electrodes (electrode numbers 3-9 in Figure 2) is sufficiently low.

Navigation Subsystem

The navigation subsystem consists mainly of a differential quality GPS system ($< 1\text{m}$ position accuracy). As suggested in the system block diagram in Figure 2, it is highly desirable that the navigation system be interfaced with a digital Fathometer. However, we have not always had such a Fathometer available. We have used many different types of GPS receivers including marine differential units (Coast Guard or U.S. Army Corps of Engineers radio correction broadcasts), satellite corrected GPS receivers such as the Trimble (Trimble LandStar), and a militarized version of a hand-held GPS receiver. Some of these receivers have had their own data loggers and have been used to store navigation fixes and the corresponding GPS time at 1-sec intervals. At other times, we have been able to configure the receiver to transmit periodic NMEA sentences containing time, position, and sometimes speed and heading over a serial RS-232C port. These sentences are captured on a spare COM port on the Data Acquisition computer and stored to its hard disk.

Some of the better marine GPS systems are integrated with a Fathometer and will record water depth directly. However, we have installed our system aboard only one vessel where this was the case. The system shown in Figure 1 included a separate Fathometer with serial output. A commercially available hydrographic survey package (HypackTM - Coastal Oceanographics, Inc) was used to merge the fathometer measurements with the appropriate navigation fixes and then both retransmit it to our data acquisition computer and store the data on the laptop computer that was running Hypack. In that installation, the customer supplied both the vessel and the navigation sub-system.

Resistivity/IP Measuring Subsystem

The resistivity/IP measuring sub-system consists of a Zonge GDP-32/32^{II} receiver with 7 analog channels. The transmitter has an output power rating of approximately 600W and is powered with a primary supply of 24Vdc. In fresh water where contact resistance is significantly higher than in salt water, we employ a DC-DC “Power Booster” that can step up the 24Vdc primary voltage to voltages as high as 400Vdc. The receiver is connected to the 6 receiver dipoles (i.e., M1-M2, ... , M5-M6 in Figure 2). A 7th analog channel is used to monitor a voltage proportional to the output current (typically 1V/A).

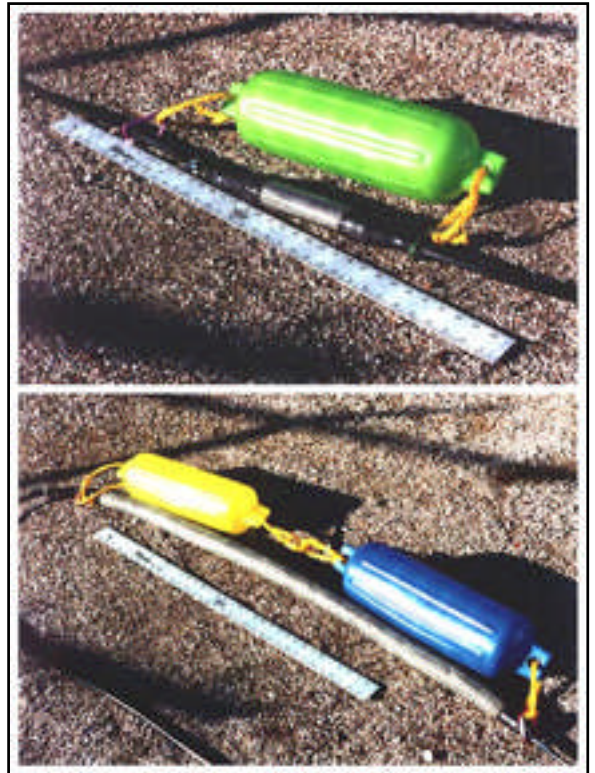

Figure 4: Potential (top) and current electrodes.

Operating with special firmware, the receiver performs a periodic resistivity/IP measurement and stamps it with the time of the reading using the receiver’s precision real time clock.⁴ These data are stored both internally in a battery-backed “data cache” and transmitted out the receiver’s COM port for capture by the data acquisition computer. The times recorded with the resistivity and navigation data form the basis for associating a position with each of our measurements.

Data Acquisition Subsystem

Although the navigation and the resistivity/IP measuring subsystems generally record their data independently, a few steps in the post-processing of data are greatly facilitated if not totally eliminated when the navigation data are captured on a single acquisition computer. We are using a laptop computer with 2 COM ports for acquisition. At this point, our acquisition software can easily be described as *ad hoc*. But with each survey, we develop new or modified software capabilities both for acquisition and for post-processing and we look forward in the future to having a fully integrated system for acquiring these data and performing some of the necessary processing in real time. Among other things, we hope that new versions of our acquisition software will implement a real-time “water-fall” display of the 6 resistivity and 6 IP traces we acquire.

DATA PROCESSING

The system described in the previous section can easily acquire 30-40 line-km of dipole-dipole data per day when surveying long lines. Data are usually acquired at 4-sec intervals using surveying speeds of 4-5 km/hr. This means we acquire a set of 6 resistivity and IP measurements at approximately 5-m (half-dipole) intervals. This is a huge amount of data to process. Our system for processing these

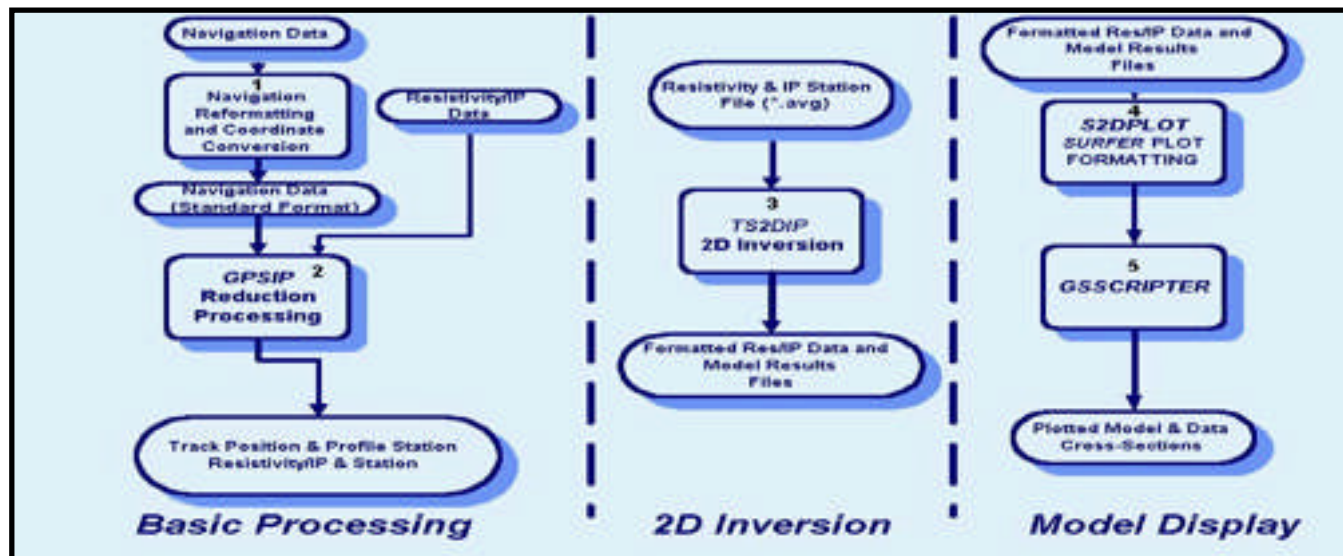

Figure 5: Flow diagram showing major steps in processing marine resistivity/IP data.

⁴ The standard Zonge GDP-32/32^{II} receivers have timing circuitry and a real time clock driven by an ultra-stable quartz oscillator. The oscillator is also used to maintain local synchronous phase references for all binary frequencies from 2^{-10} Hz to 2^{14} Hz. Once the oven-stabilized crystal has been warmed up, time drift is less than a millisecond per day. The real time clock keeps time to the second. A recent upgrade to the clock hardware permits the clock to be read to the nearest 1/32 sec.

data has evolved over a period of more than 4-years. The flow diagram in Figure 5 shows the major steps in the processing flow. The major steps include:

1. Basic Processing
2. Model Inversion
3. Model Display

Basic Processing

Two main functions are accomplished in the data reduction step. Firstly, we merge the navigation data with the resistivity data and thereby obtain data files that relate vessel position along the survey track (i.e., station number) to a geographic position. Secondly, we estimate the position of each of the 9 electrodes in our streamer cable and use these positions to calculate apparent resistivities.

Navigation Reduction - Because of the variety of navigation systems with which we have had to contend, we generally run our navigation file through a reformatting program (box 1 in Figure 5) to reformat the navigation data and present it in a standard format to the main reduction program, GPSIP (box 2 in Figure 5). Using the navigation data, GPSIP computes an accumulated “station number” starting at the beginning of the line. The station number is the accumulated distance along the profile expressed in appropriate distance units (usually meters or feet). Among other things, GPSIP produces a file that tabulates station number and geographic position. We use these data either graphically or numerically to relate a profile plot point expressed as a station number to a geographic position. Figure 6 is a graphic representation of a track station plot.

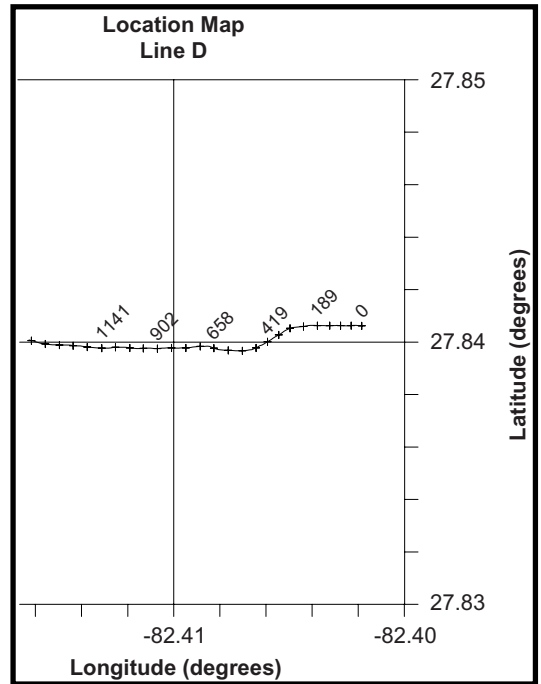

Figure 6: Portion of track plot.

Resistivity Reduction and Plot Point Estimation – Resistivity reduction has evolved extensively over the 4+ years that we have been running these surveys. In our original survey, we assumed that the streamer cable was in line with the survey vessel’s heading as illustrated in Figure 7a. Using the coordinates of the GPS antenna, the geometry of the cable and its tie-off point on the vessel, we used basic analytic geometry to compute the geographic positions of each of the 6 plot points for the dipole measurements. This works well for surveys with long straight tracks, but proves unsatisfactory when the survey vessel changes course more than a few degrees while surveying. We have called our early

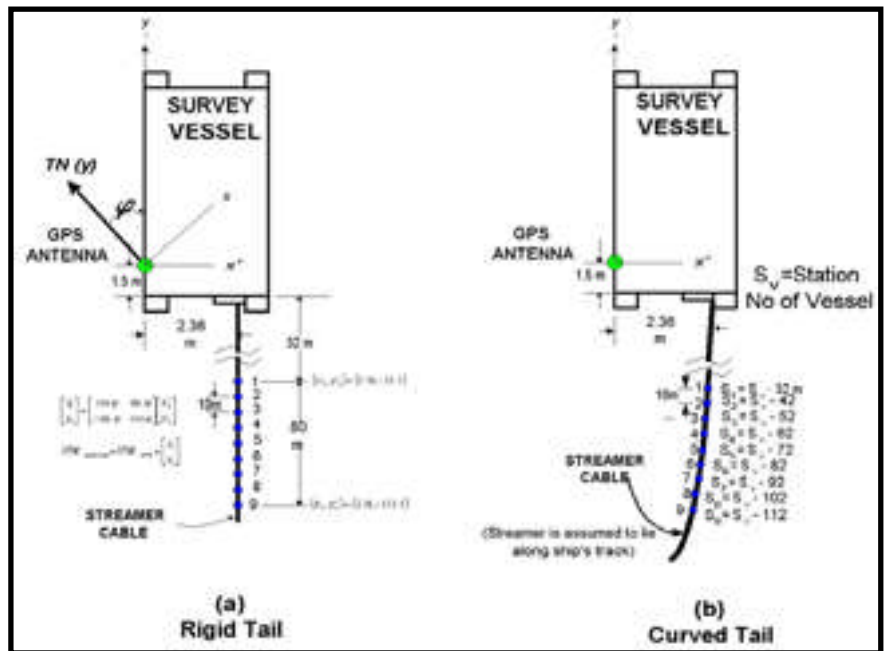

Figure 7: Figure showing geometrical relationship for estimating streamer electrode position.

survey vessel changes course more than a few degrees while surveying. We have called our early

assumption the “Rigid Tail” assumption, and Figure 8 illustrates the consequences of that assumption when it is applied to a profile where there have been significant course changes. The Figure shows the ship’s GPS positions as small circles. It plots the estimated position of the 6 dipole-dipole plot points as a sequence of 6 equal-spaced “+” symbols. This plot shows how the “Rigid Tail” reduction creates a fan

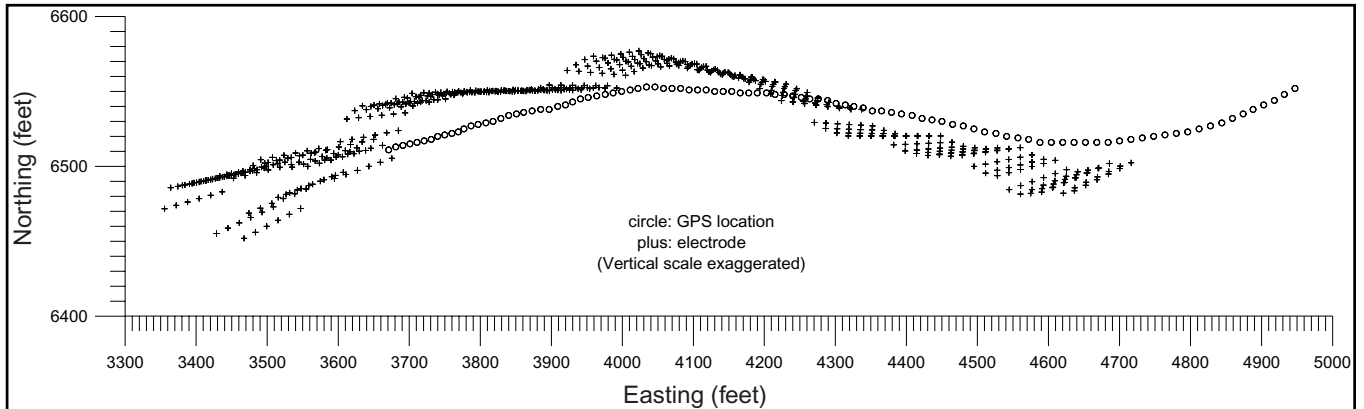

Figure 8: Track of survey ship with electrode locations estimated with “Rigid Tail” assumption.

effect during a course change. Where it is severe, the fan effect shown in Figure 8 can significantly distort our efforts to model and display a resistivity cross-section.

We have subsequently modified our “Rigid Tail” assumption to a “Curved Tail” assumption. We assume that under gentle maneuvering, the streamer cable will follow the ship’s track as illustrated in Figure 7b. The station number of each electrode and plot point is used to interpolate the geographic coordinates from the GPS track. The observed voltage differences are reduced to apparent resistivity based on four sets of electrode coordinates that are not necessarily co-linear. Figure 9 is an example of data that have been reduced with GPSIP.

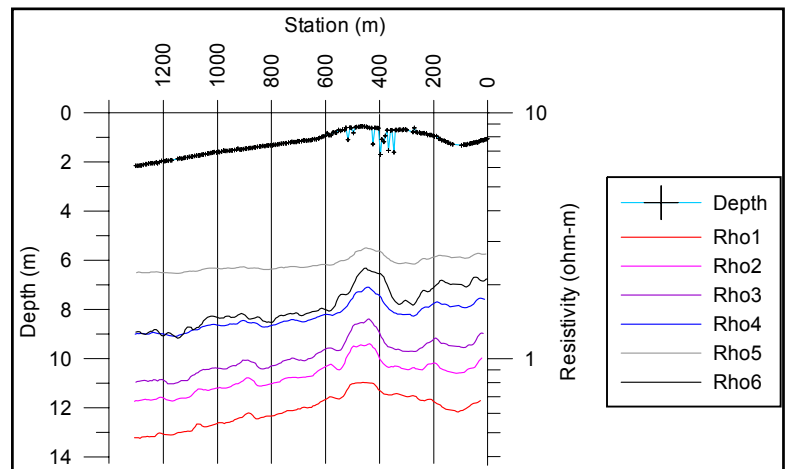

Figure 9: Portion of resistivity profile plot.

Model Inversion

Our data processing steps normally include the inversion of the apparent resistivity profiles using a 2.5D smooth-model inversion program described by MacInnes and Zonge [3]. This program has been modified to invert dipole-dipole pseudo-sections with as many as 150 dipoles. Since our profiles are typically many kilometers long, we divide the profile into sections of approximately 1200m that overlap with adjacent sections by at least 100m. Figure 10 shows the model section, the calculated resistivity, and the observed resistivity for one section of a profile acquired during a recent survey in a shallow marine environment in Florida.

Although the data for Figure 10 included Fathometer information, we are not yet able to include the Fathometer profile into our resistivity model and thus constrain the model. However, we are currently working to implement a modification to our inversion program that will allow us to

incorporate that information. We believe that this modification will considerably improve the image generated by the inversion process.

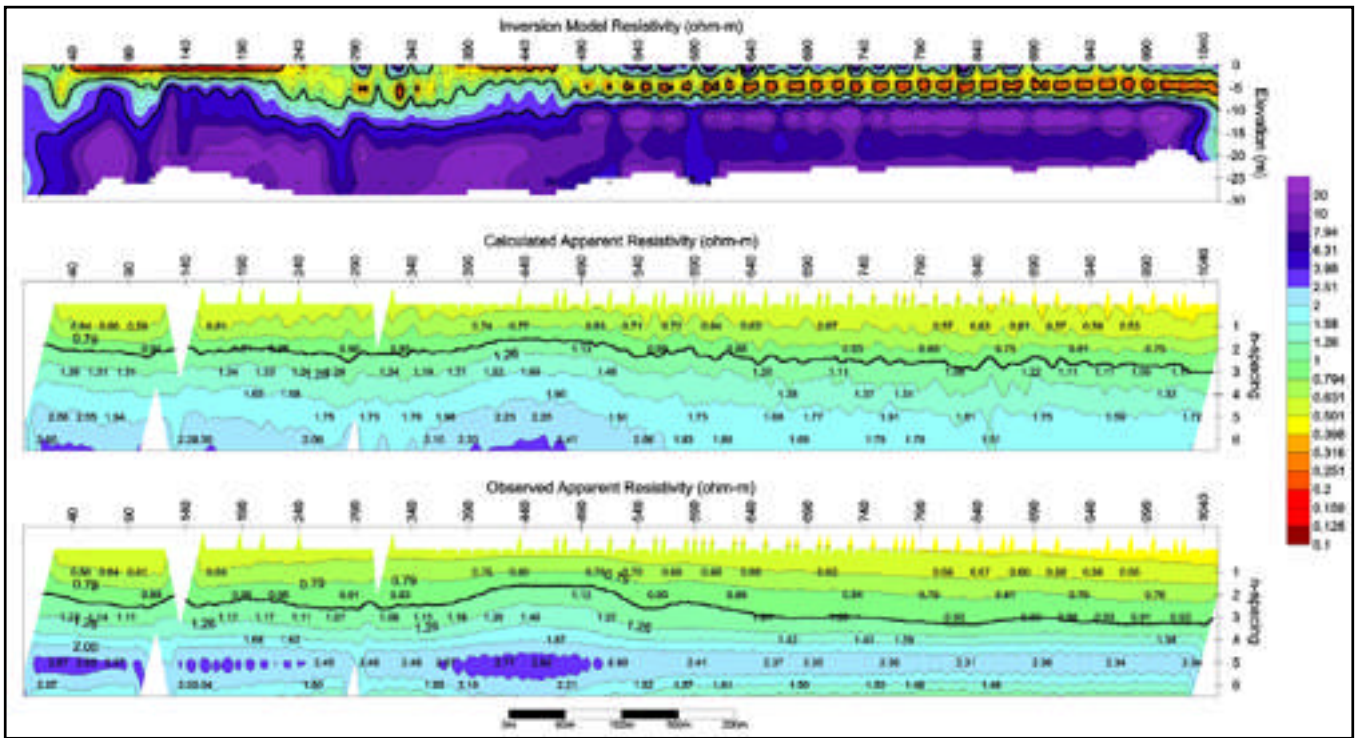

Figure 10: 2.5D Smooth-model Inversion results.

Model Display

The inversion results are output into data files that are compatible with either SURFER (Golden Software) or Oasis Montaj (GeoSoft). The model cross-section in Figure 10 was generated using SURFER 7.0.

APPLICATIONS

Most of the interest in applying these towed-array resistivity measurements has come from the ground-water community. Several papers presented at this symposium present data acquired using the Zonge system. In connection with hydrology, estimates of the resistivity of the sub-bottom can be used as a basis for estimating the resistivity (hence salinity) of the pore water. In shallow estuaries, freshwater often seeps into the estuary from aquifers that crop out down gradient from nearby land areas. Changes in the pore water resistivity cause a significant increase in the resistivity according to well-known empirical laws governing the resistivity in porous rocks. Archie's law [4] relates bulk resistivity of a porous rock to a "Formation Factor" according the formula

$$\rho_T = \rho_f F; F = \phi^{-m} \text{ (Archie's Law)} \quad (1)$$

Where

ρ_T = The bulk resistivity of the saturated material
 ρ_f = The resistivity of the saturating fluid

- F = The formation factor
- ϕ = Fractional porosity of matrix material
- m = cementation exponent (for unconsolidated sands ~ 2)

Archie's law suggests that the bulk resistivity of an unconsolidated sand/silt layer in a shallow estuary might be up to 4 times the resistivity of the seawater (typically about 0.3-0.4 ohm-m). Thus, in the absence of fresh or brackish water in the subsurface, we expect a resistivity in the sub-bottom of about 1-1.5 ohm-m. Notice in the model cross-section shown in Figure 10 that the model resistivity in the zone 10-15m deep is more than 20 ohmmeters. Unless there is a significant change in the formation factor of the sub-bottom, the model resistivities suggest that the water saturated the sub-bottom has a resistivity of 5 ohmmeters or more (border-line fresh water).

Lest we forget, this system is also capable of measuring the IP response. Although our customers have been primarily interested in ground-water applications, there are potential applications for using the IP measurements. Wynn [5] has observed a measurable IP response associated with titaniferous beach sands. The response is small and requires that the streamer be submerged so that it is closer to the sub-bottom. That material containing small amounts of disseminated metallic mineralization produces an IP effect comes as no surprise to mining geophysicists. But IP effects are also associated with massive sulfides and with smaller but still finite-sized metallic objects. Indeed, one of the earliest applications of the IP method was the Mark 5 Beach Mine Detector developed and deployed briefly during World War II [6]. Additional anecdotal comments have appeared in the literature suggesting that IP measurements may be useful for detecting metallic objects resting on the water bottom or in the near sub-bottom.

CONCLUSIONS

We have described a system for acquiring resistivity and IP data from an electrode streamer towed behind a small outboard motor-powered vessel. Assembled from commercially available instruments for measuring resistivity and IP, the system can be installed aboard a small survey vessel in a few hours and is designed for deployment in shallow water of depth 5-10m. . It can acquire dipole-dipole data ($n=1-6$) at the rate of 10's of line-km per day. We have deployed this system primarily in connection with ground-water investigations. However, we expect that other applications will emerge as environmental scientists become acquainted with the economics of the deployment of towed-array resistivity measurements. A key advantage to the adaptation of the common geophysical techniques for deployment in shallow water is the access that these water bodies provide into areas that are otherwise inaccessible from the landside. As geophysicists, we often find that geophysical surveys along shorelines are rendered difficult or impossible because of complex land ownership and the cultural effects (e.g., fences and buried utility lines). But in a small craft, we are free to float right by the "end of the dock".

REFERENCES

1. *Schlumberger, Log Interpretation Charts. 1972, Schlumberger Limited.*
2. *Elliot, C.L., Theoretical Response-Three Layered Earth. undated, Elliot Geophysical Company: Tucson, AZ.*
3. *MacInnes, S., and Ken Zonge. Two-dimensional Inversion of Resistivity and IP Data with Topography. in 102nd Annual Northwest Mining Association Convention. 1996. Spokane, WA.*
4. *Archie, G.E., The electrical resistivity log as an aid in determining some reservoir characteristics. AIME Tech. Paper 1422, 1942.*
5. *Wynn, J.C., Titanium geophysics: The application of induced polarization to sea-floor mineral exploration. Geophysics, 1988. 53(3): p. 386-401.*
6. *Grow, L.M., Induced Polarization for Geophysical Exploration, in The Leading Edge. 1982. p. 55-70.*